

lenovo

IdeaPad Z370/Z470/ Z570

User Guide v1.0



Read the safety notices and important tips in the included manuals before using your computer.

ideapad

Notes

- Before using the product, be sure to read *Lenovo Safety and General Information Guide* first.
- Some instructions in this guide may assume that you are using Windows® 7. If you are using other Windows operating system, some operations may be slightly different. If you are using other operating systems, some operations may not apply to you.
- The features described in this guide are common to most models. Some features may not be available on your computer and/or your computer may include features that are not described in this user guide.
- The illustrations used in this manual are for Lenovo IdeaPad Z370 unless otherwise stated.
- The illustrations in this manual may differ from the product you are using.

Regulatory Notice

- To refer to it, go to <http://consumersupport.lenovo.com/> and click **User guides and manuals**.

First Edition (December 2010)

© Copyright Lenovo 2010.

LENOVO products, data, computer software, and services have been developed exclusively at private expense and are sold to governmental entities as commercial items as defined by 48 C.F.R. 2.101 with limited and restricted rights to use, reproduction and disclosure. LIMITED AND RESTRICTED RIGHTS NOTICE: If products, data, computer software, or services are delivered pursuant a General Services Administration "GSA" contract, use, reproduction, or disclosure is subject to restrictions set forth in Contract No. GS-35F-05925.

Contents

Chapter 1. Getting to know your computer..... 1

- Top view1
- Left-side view4
- Right-side view6
- Front view8
- Bottom view9

Chapter 2. Learning the basics..... 12

- First use.....12
- Using AC adapter and battery ...14
- Using the touchpad.....16
- Using the keyboard.....17
- Connecting external devices.....20
- Special keys and buttons.....23
- System status indicators.....27
- Securing your computer.....29
- Enabling NVIDIA® Optimus™
(on select models).....30

Chapter 3. Connecting to the Internet..... 31

- Wired connection31
- Wireless connection33

Chapter 4. OneKey Rescue system.....35

- OneKey Rescue system 35

Chapter 5. Troubleshooting ...38

- Frequently asked questions..... 38
- Troubleshooting..... 40

Appendix A. CRU instructions.....45

- Replacing the battery pack 45
- Replacing the hard disk drive.... 47
- Replacing memory..... 56
- Removing the optical drive 59

Trademarks.....61

Chapter 1. Getting to know your computer

■ ■ Top view

■ Z370/Z470

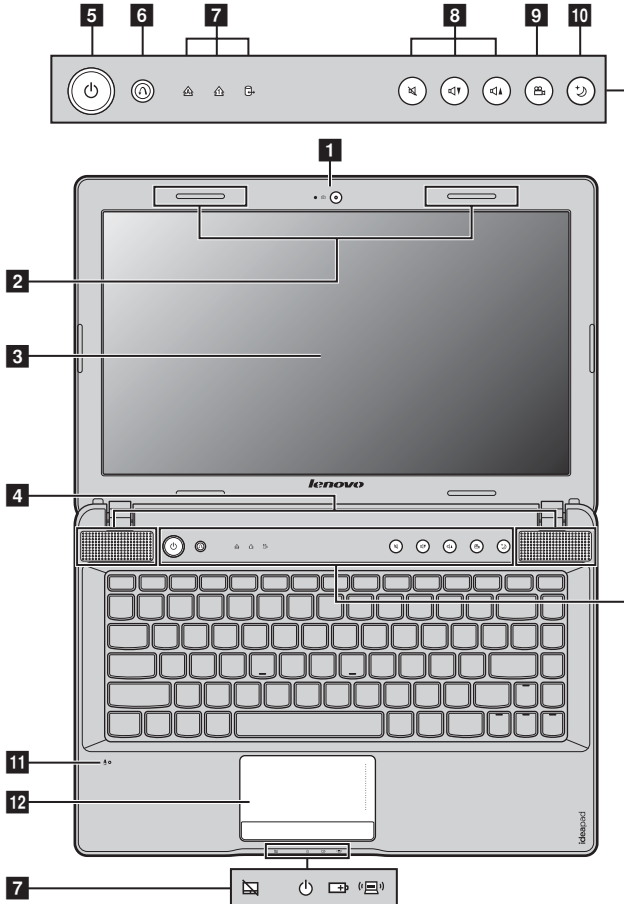

Chapter 1. Getting to know your computer

■ Z570

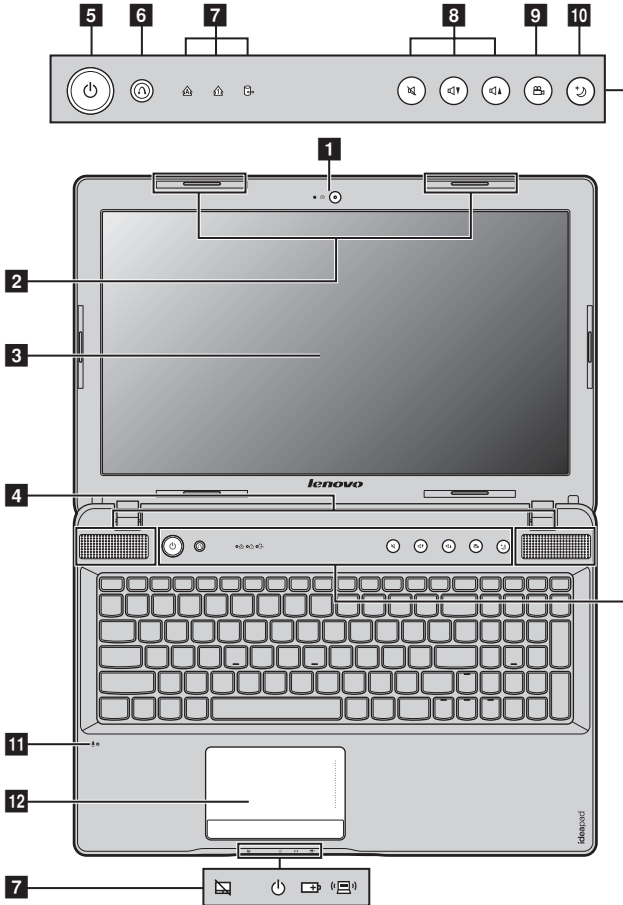

⦿ Attention:

- Do NOT open the display panel beyond 130 degrees. When closing the display panel, be careful NOT to leave pens or any other objects in between the display panel and the keyboard. Otherwise, the display panel may be damaged.

Chapter 1. Getting to know your computer

- 1 Integrated camera** Use the camera for video communication.
- 2 Wireless module antennas** The built-in antennas ensure optimal reception of wireless radio.
- 3 Computer display** The computer display with LED backlight provides brilliant visual output.
- 4 Speakers** The stereo speakers provide rich and powerful sound.
- 5 Power button** Press this button to turn on the computer.
- 6 OneKey Rescue system button** Press this button to start OneKey Rescue system when the computer is powered off.

Note: For details, see “OneKey Rescue system” on page 35.

- 7 System status indicators** For details, see “System status indicators” on page 27.
- 8 Volume buttons** Use these buttons to adjust volume.
- 9 OneKey Theater button** Touch this button to select a preferred scenario mode.

Note: For details, see “OneKey Theater button” on page 24.

- 10 Thermal management button** Touch this button to control the speed at which the dissipation fan spins. Touch this button to perform dust cleaning.

Note: For details, see “Thermal management button” on page 25.

- 11 Built-in microphone** The built-in microphone (with noise reduction) can be used for video conferencing, voice narration, or simple audio recordings.
- 12 Touchpad** The touchpad functions as a conventional mouse.

Note: For details, see “Using the touchpad” on page 16.

Chapter 1. Getting to know your computer

■ ■ Left-side view

■ Z370/Z470

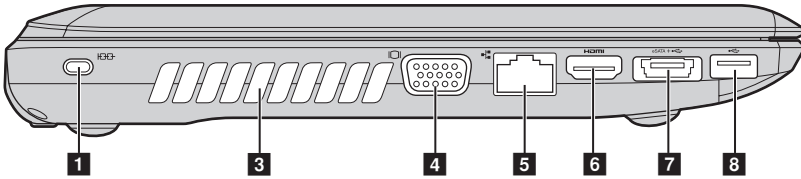

■ Z570

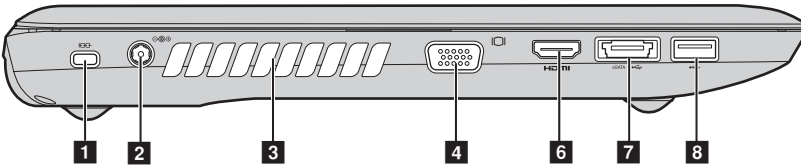

- 1 Kensington slot** Attach a security lock (not supplied) here.

Note: For details, see “Attaching a security lock (not supplied)” on page 29.

- 2 AC power adapter jack** Connect the AC adapter here.

Note: For details, see “Using AC adapter and battery” on page 14.

- 3 Fan louvers** Dissipate internal heat.

Note: Make sure that none of the fan louvers are blocked or else overheating of the computer may occur.

- 4 VGA port** Connects to external display devices.

- 5 RJ-45 port** This port connects the computer to an Ethernet network.

Note: For details, see “Wired connection” on page 31.

- 6 HDMI port** Connects to devices with HDMI input such as a TV or a display.

Chapter 1. Getting to know your computer

- 7 eSATA/USB combo port** Connects to eSATA or USB devices.

Note: For details, see “Connecting USB devices” on page 21.

- 8 USB port** Connects to USB devices.

Note: For details, see “Connecting USB devices” on page 21.

Chapter 1. Getting to know your computer

Right-side view

Z370

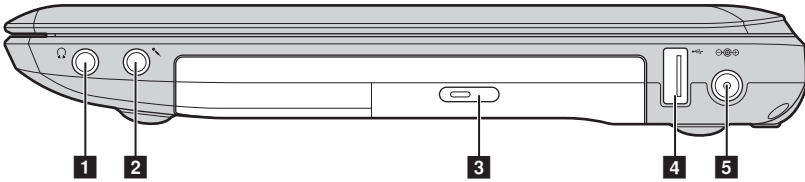

Z470

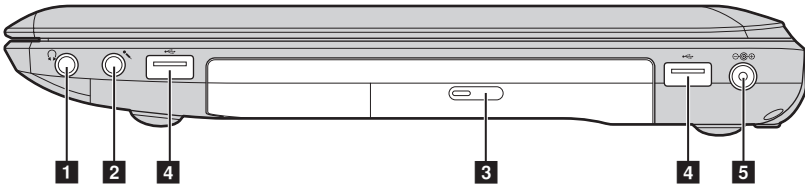

Z570

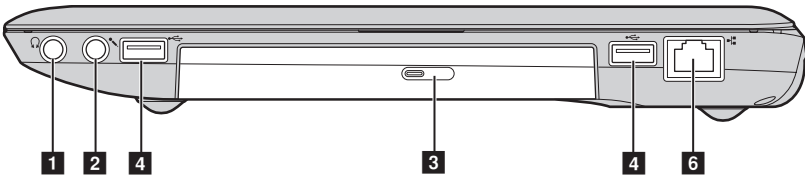

1 Headphone jack Connects to external headphones.

ⓘ **Attention:**

- Listening to music at high volume over extended periods of time may damage your hearing.

2 Microphone jack Connects to external microphones.

3 Optical drive Reads/Burns optical discs.

Chapter 1. Getting to know your computer

4 USB port Connects to USB devices.

Note: For details, see “Connecting USB devices” on page 21.

5 AC power adapter jack Connect the AC adapter here.

Note: For details, see “Using AC adapter and battery” on page 14.

6 RJ-45 port This port connects the computer to an Ethernet network.

Note: For details, see “Wired connection” on page 31.

Chapter 1. Getting to know your computer

■ ■ Front view

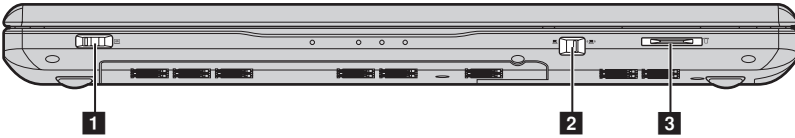

- 1 GPU switch (on select models)** Slide and release this switch to enable or disable NVIDIA Optimus.
- 2 Integrated wireless device switch** Slide this switch to turn on or turn off the wireless radio of all wireless devices on your computer.
- 3 Memory card slot** Insert memory cards (not supplied) here.

Note: For details, see “Using memory cards (not supplied)” on page 20.

■ ■ Bottom view

■ Z370

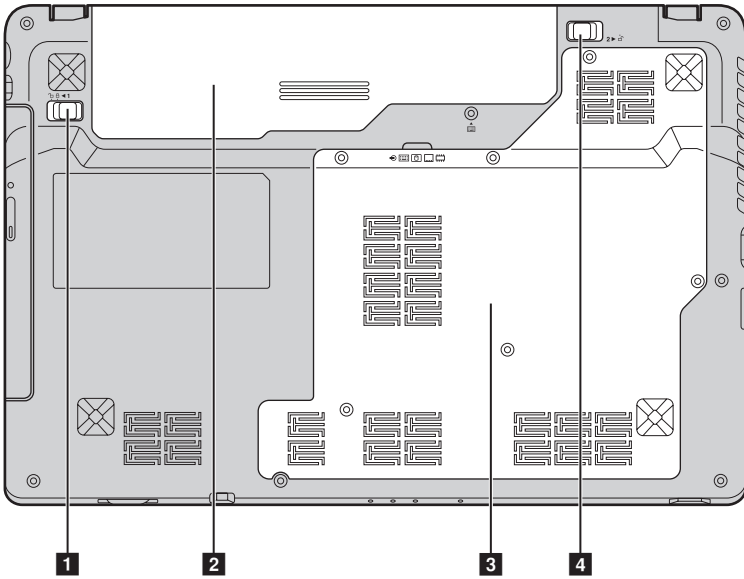

Chapter 1. Getting to know your computer

■ Z470

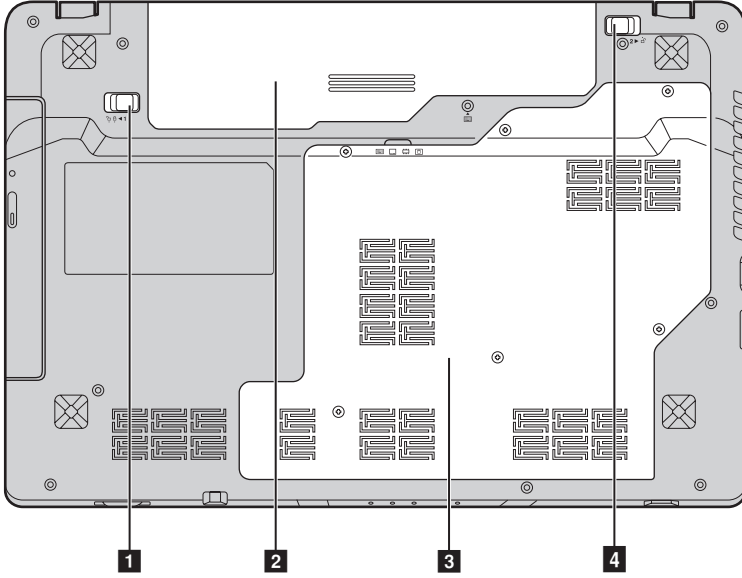

■ Z570

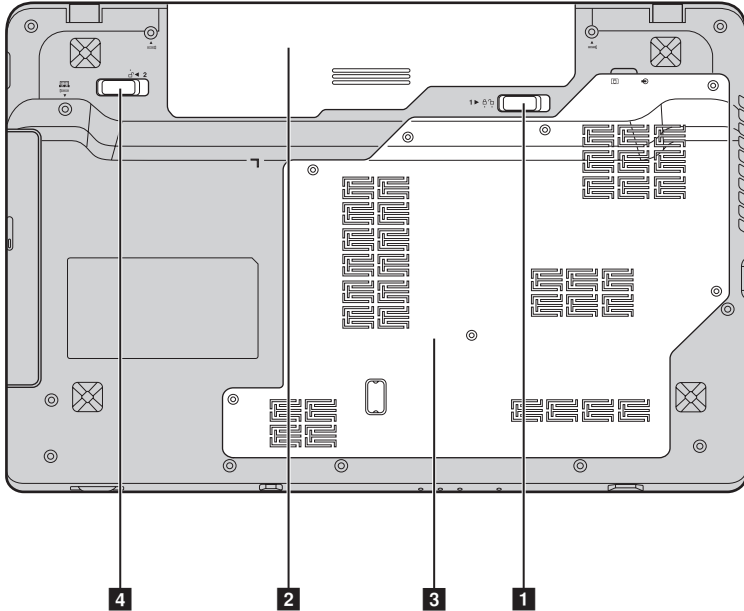

1 Battery latch - manual

The manual battery latch is used to keep the battery pack secured in place.

2 Battery pack

For details, see “Using AC adapter and battery” on page 14.

3 Hard disk drive / Memory / Central processing unit / Mini PCI Express Card slot compartment

4 Battery latch - spring loaded

The spring-loaded battery latch keeps the battery pack secured in place.

Chapter 2. Learning the basics

■ ■ First use

■ Reading the manuals

Read the supplied manuals before using your computer.

■ Connecting to the power

The supplied battery pack is not fully charged at purchase.

To charge the battery and begin using your computer, insert the battery pack and connect the computer to an electrical outlet. The battery is automatically charged while the computer is running on AC power.

Installing the battery pack

Refer to the supplied *Setup Poster* to install the battery pack.

Connecting the computer to an electrical outlet

- ① Connect the power cord to the AC adapter.
- ② Connect the AC adapter to the AC power adapter jack of the computer firmly.
- ③ Plug the power cord into an electrical outlet.

■ Turning on the computer

Press the power button to turn on the computer.

■ Configuring the operating system

You may need to configure the operating system when it is first used. The configuration process may include the procedures below.

- Accepting the end user license agreement
- Configuring the Internet connection
- Registering the operating system
- Creating a user account

■ Putting your computer into sleep state or shutting it down

When you finish working with your computer, you can put it into sleep state or shut it down.

Putting your computer into sleep state

If you will be away from your computer for only a short time, put the computer into sleep state.

When the computer is in sleep state, you can quickly wake it to resume use, and bypass the startup process.

To put the computer into sleep state, do one of the following.

- Click  and select **Sleep** from the Start menu.
- Press **Fn + F1**.

Note: Wait until the power indicator light starts blinking (indicating that the computer is in sleep state) before you move your computer. Moving your computer while the hard disk is spinning can damage the hard disk, causing loss of data.

To wake the computer, do one of the following.

- Press the power button.
- Press any key on the keyboard.

■ Shutting down your computer

If you are not going to use your computer for a day or two, shut it down.

To shut down your computer, click  and select **Shut down** from the Start menu.

Chapter 2. Learning the basics

■ ■ Using AC adapter and battery

■ Checking battery status

You can determine the percentage of battery power remaining by checking the battery icon in the notification area.

Note: As each computer user has different habits and needs, it is difficult to predict how long a battery charge will last. There are two main factors:

- The amount of energy stored in the battery when you commence work.
- The way you use your computer: for example, how often you access the hard disk drive and how bright you make the computer display.

■ Charging the battery

When you find that the battery power is low, you need to charge the battery or replace it with a fully charged one.

You need to charge the battery in any of the following situations:

- When you purchase a new battery
- If the battery status indicator starts blinking
- If the battery has not been used for a long time

Notes:

- You are advised to insert the battery pack when using your computer to prevent small particles from entering the inside of your computer.
- To increase the life of the battery pack, the computer does not start recharging the battery immediately after it drops from fully charged.
- Charge the battery at a temperature between 50 °F and 86 °F (10 °C-30 °C).
- Full charge or discharge is not required.

■ Removing the battery pack

If you are not going to use the computer for an extended period of time, or if you need to send your computer to Lenovo for service, etc. remove the battery pack from the computer. Before removing the battery pack, make sure the computer has been shut down.

■ Handling the battery

If the rechargeable battery pack is replaced with an incorrect type, there may be danger of an explosion. The battery pack contains a small amount of harmful substances. To avoid possible injury and detriment to the environment, pay attention to the following points:

- Replace only with a battery of the type recommended by Lenovo.
- Keep the battery pack away from fire.
- Do not expose the battery pack to water or rain.
- Do not attempt to disassemble the battery pack.
- Do not short-circuit the battery pack.
- Keep the battery pack away from children.
- Do not put the battery pack in trash that is disposed of in landfills. When disposing of the battery, comply with local ordinances or regulations and your company's safety standards.

Chapter 2. Learning the basics

■ ■ Using the touchpad

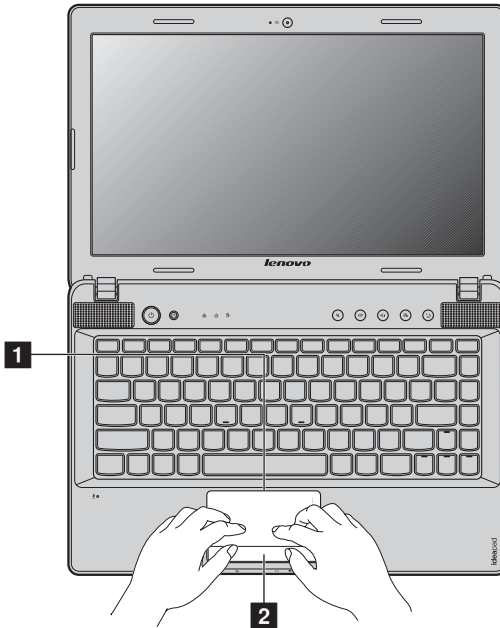

1 Touchpad

To move the cursor on the screen, slide your fingertip over the pad in the direction in which you want the cursor to move.

2 Touchpad button

The function of the left/right side corresponds to that of the left/right mouse button on a conventional mouse.

Note: You can enable/disable the touchpad using **Fn + F6**. When the touchpad indicator is lit, the touchpad is disabled.

■ Using the keyboard

Your computer has a numeric keypad and function keys incorporated in its standard keyboard.

■ Numeric keypad

Z370/Z470

The keyboard has keys that, when enabled, work as a 10-key numeric keypad. To enable or disable the numeric keypad, press **Fn + F8**.

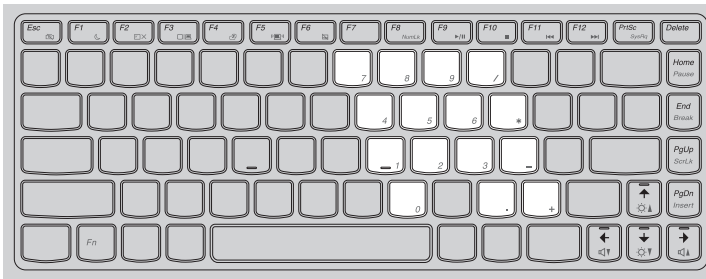

Z570

The keyboard has a separate numeric keypad. To enable or disable the numeric keypad, press the **Num Lock** key.

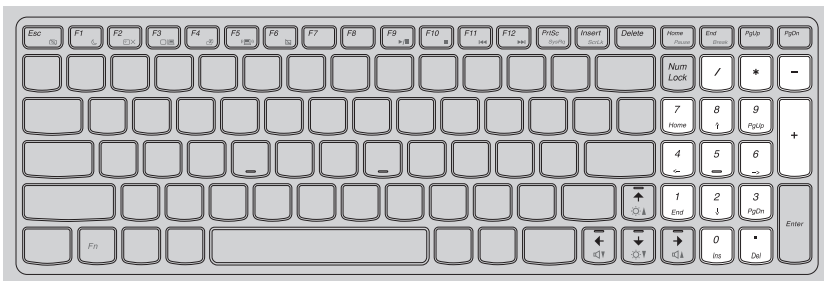

Note: The Num lock indicator  will light on if the numeric keypad is enabled.

Chapter 2. Learning the basics

■ Function key combinations

Through the use of the function keys, you can change operational features instantly. To use this function, press and hold **Fn** **1**; then press one of the function keys **2**.

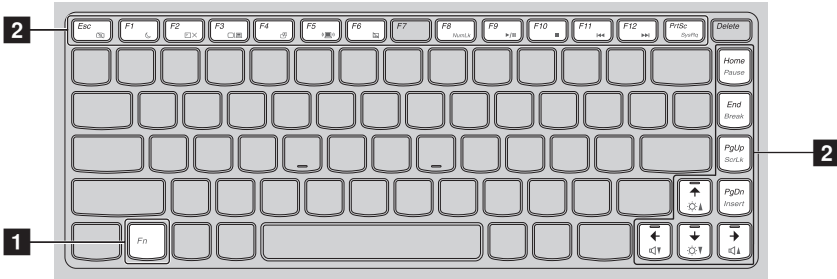

Chapter 2. Learning the basics

The following describes the features of each function key.

Fn + Esc:	Turn on/off the integrated camera.
Fn + F1:	Enter sleep mode.
Fn + F2:	Turn on/off the backlight of the LCD screen.
Fn + F3:	Open the interface for the display device switch to select this notebook or an external display.
Fn + F4:	Open the interface for display resolution settings.
Fn + F5:	Open the interface for integrated wireless devices settings (On/Off).
Fn + F6:	Enable/Disable the touchpad.
Fn + F8 (Z370/Z470):	Enable/Disable the numeric keypad.
Fn + F9:	Start/Pause playback of Windows Media Player.
Fn + F10:	Stop playback of Windows Media Player.
Fn + F11:	Skip to the previous track.
Fn + F12:	Skip to the next track.
Fn + Insert (Z570): Fn + PgUp (Z370/Z470):	Enable/Disable the scroll lock.
Fn + PrtSc:	Activate the system request.
Fn + Home:	Activate the pause function.
Fn + End:	Activate the break function.
Fn + PgDn (Z370/Z470):	Activate the insert function.
Fn + ↑ / ↓:	Increase/Decrease display brightness.
Fn + → / ←:	Increase/Decrease sound volume.

Chapter 2. Learning the basics

■ ■ Connecting external devices

Your computer has a wide range of built-in features and connection capabilities.

■ Using memory cards (not supplied)

Your computer supports the following types of memory cards:

- Secure Digital (SD) card
- MultiMediaCard (MMC)
- Secure Digital PRO (SD PRO)
- Memory Stick PRO (MS PRO)
- xD-Picture (xD) card

Notes:

- Insert **ONLY** one card in the slot at a time.
- This card reader does not support SDIO devices (e.g., SDIO Bluetooth, etc.).

Inserting a memory card

- ➊ Push the dummy card until you hear a click. Gently pull the dummy card out of the memory card slot.

Note: The dummy card is used for preventing dust and small particles from entering the inside of your computer when the memory card slot is not in use. Retain the dummy card for future use.

- ➋ Slide the memory card in until it clicks into place.

Removing a memory card

- ➊ Push the memory card until you hear a click.
- ➋ Gently pull the memory card out of the memory card slot.

Note: Before removing the memory card, disable it via Windows safely remove hardware and eject media utility to avoid data corruption.

■ Connecting USB devices

You can connect a USB device to your computer by inserting its USB plug (Type A) into the USB port (or eSATA/USB combo port) on your computer.

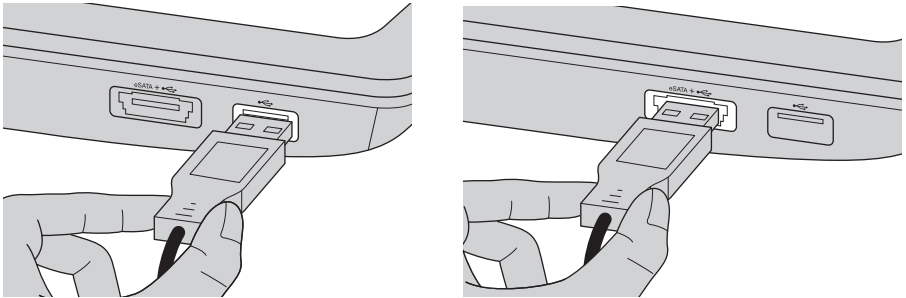

Model	Number of USB port	Number of eSATA/USB combo port
Z370	2	1
Z470, Z570	3	1

The first time you plug a USB device into a particular USB port on your computer, Windows automatically installs a driver for that device. After the driver is installed, you can disconnect and reconnect the device without performing any additional steps.

Note: Typically, Windows detects a new device after connecting it, and then installs the driver automatically. However, some devices may require you to install the driver before connecting. Check the documentation provided by the device's manufacturer before connecting the device.

Before disconnecting a USB storage device, make sure your computer has finished transferring data by that device. Click the **Safely Remove Hardware** icon in the notification area of Windows to remove the device before disconnecting.

Note: If your USB device uses a power cord, connect the device to a power source before connecting it. Otherwise, the device may not be recognized.



Chapter 2. Learning the basics

■ Connecting *Bluetooth* enabled devices (on select models)

If your computer has an integrated *Bluetooth* adapter card, it can connect to and transfer data wirelessly with other *Bluetooth* enabled devices, such as notebook computers, PDAs and cell phones. You can transfer data between these devices without cables and up to 10 meters range in open space.

Note: The actual maximum range may vary due to interference and transmission barriers. To get the best possible connection speed, place the device as near your computer as possible.

Enabling *Bluetooth* communications on your computer

- 1 Slide the integrated wireless device switch from  to .
- 2 Press **Fn + F5** to make configuration.

Notes:

- When you do not need to use the *Bluetooth* function, turn it off to save battery power.
- You need to pair the *Bluetooth* enabled device with your computer before you can transfer data between them. Read the documentation supplied with the *Bluetooth* enabled device for details on how to pair the device with your computer.

■ ■ Special keys and buttons

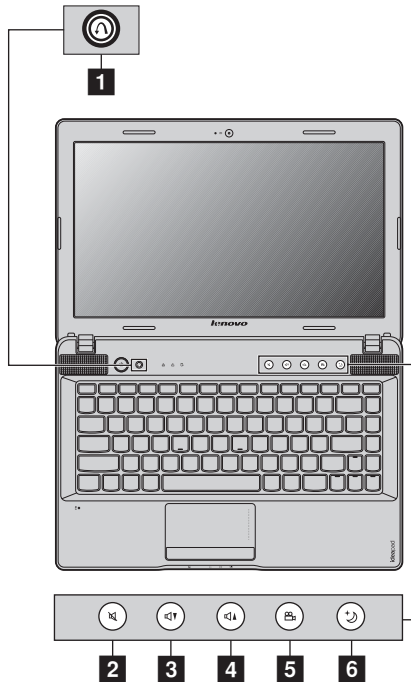

■ OneKey Rescue system button **1**

- When the computer is powered-off, press this button to start Lenovo OneKey Rescue system.
- In Windows operating system, press this button to start Lenovo OneKey Recovery system.

Note: For details, see “OneKey Rescue system” on page 35.

■ Volume buttons **2 ~ 4**

- 2** Mute/Unmute
- 3** Volume down
- 4** Volume up

Chapter 2. Learning the basics

■ OneKey Theater button 5

Lenovo OneKey Theater provides five scenario modes for using your computer in different ways: normal mode, movie mode, music mode, picture mode, and intelligent mode. These modes are preset enhancements by Lenovo to improve visual and aural experiences via your computer in different usage scenarios. You can manually choose between normal, movie and intelligent mode. Picture or music mode is automatically selected if your computer is in intelligent mode.

To manually select a desired mode:

- Press and release the OneKey Theater button to display the on-screen menu.
- Keep pressing and releasing the button until the icon of your desired mode is highlighted.

The computer switches to the selected mode after 2 seconds.



Normal mode

The default mode.



Movie mode

Provides enhanced visual and audio output.



Music mode

Provides enhanced audio output.



Picture mode

Provides enhanced contrast and color saturation.



Intelligent mode

Automatically switch your computer between movie, music, and picture mode according to the program that is running.

Notes:

- You can enable or disable the OneKey Theater feature via the Start menu.
- Some programs may not be compatible with intelligent mode.

■ Thermal management button

The thermal management button can be used to switch the computer between different work modes and thus control the speed at which the heat dissipation fan spins. You can choose between **standard**, **super silent**, or **efficient thermal dissipation** mode. You can also activate the dust cleaning feature by pressing and releasing the thermal control button.

Standard mode

Standard mode is the factory default mode. It is the recommended work mode for most programs.

Super silent mode

If your computer is not running large programs and you want a silent work environment, switch your computer to super silent mode. To switch to super silent mode, repeatedly press the thermal management button until  is highlighted. The computer will switch to super silent mode after three seconds.

Note: The heat dissipation fan spins at relatively low speeds in super silent mode, and thus dissipates less heat than in other modes. If large programs are running, the system may lower the voltage of the CPU (central processing unit) automatically to decrease the heat produced by the CPU. Consequently, you might experience lower system performance when the computer is running in super silent mode.

Efficient thermal dissipation mode

If large programs are running, switch your computer to **efficient thermal dissipation** mode to allow more efficient thermal dissipation. To switch to **efficient thermal dissipation** mode, repeatedly press the thermal management button until  is highlighted.

Chapter 2. Learning the basics

Performing dust cleaning

Dust tends to accumulate around the heat sink of the computer's CPU over time, reducing the dissipation capability of the heat sink. You can reduce the amount of accumulated dust by performing dust cleaning. To perform dust cleaning, repeatedly press the thermal management button until  is highlighted. Dust cleaning will start after three seconds.

When dust cleaning is activated, the heat dissipation fan spins at high and low speed alternatively to allow dust to be discharged. A complete dust cleaning process takes several minutes to complete. You can cancel the process at any time by switching the computer to **standard, super silent** or **efficient thermal dissipation** mode.

Upon completion, the computer returns to the previous mode when dust cleaning was activated.

Note: We recommend you perform dust cleaning at least once a month to reduce the amount of dust accumulation around the heat sink. Place your computer in a clean environment with good ventilation when performing dust cleaning.

■ ■ System status indicators

These indicators inform you of the computer status.

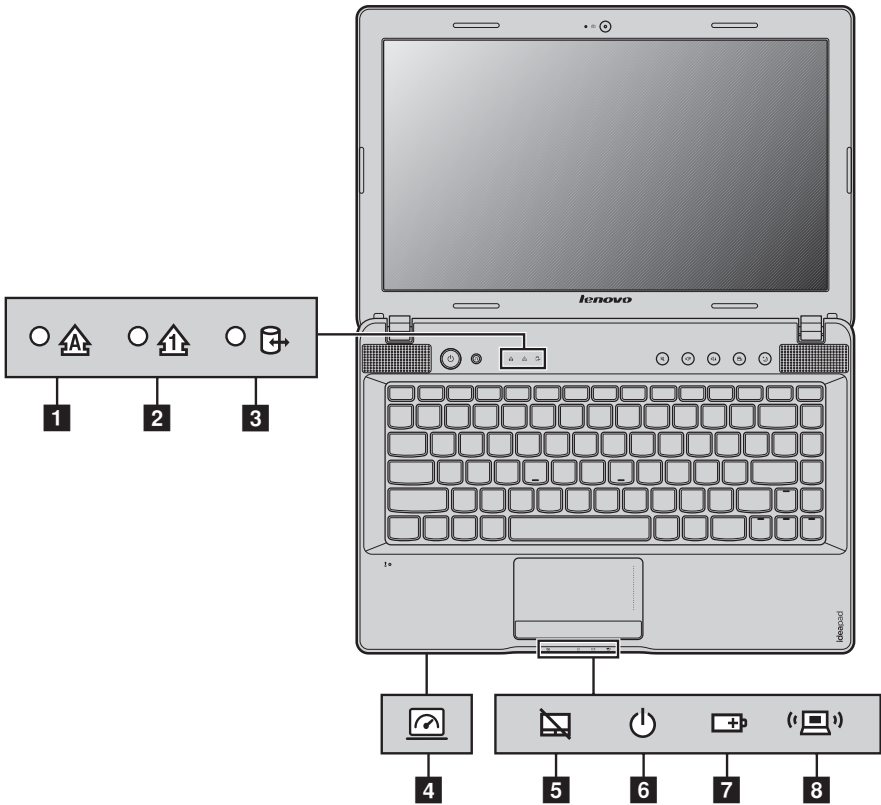

1 Caps lock indicator 



2 Num lock indicator 

3 Hard disk drive indicator 

4 GPU switch indicator (on select models) 

5 Touchpad indicator 

Chapter 2. Learning the basics

- 6** Power status indicator 
- 7** Battery status indicator 
- 8** Wireless communication indicator 

■ ■ Securing your computer

This section provides information about how to help protect your computer from theft and unauthorized use.

■ Attaching a security lock (not supplied)

You can attach a security lock to your computer to help prevent it from being removed without your permission. For details on installing the security lock, please refer to the instructions shipped with the security lock that you have purchased.

Refer to the “Left-side view” on page 4 for the location of the Kensington slot.

Notes:

- Before purchasing any security product, verify that it is compatible with this type of security keyhole.
- You are responsible for evaluating, selecting, and implementing the locking devices and security features. Lenovo offers no comment judgement or warranty regarding the function, quality or performance of locking devices and security features.

■ Using VeriFace™

VeriFace is a face recognition software which takes a digital snapshot, extracts key features of your face, and creates a digital map that becomes the system’s “password”.

If you want to activate VeriFace for the first time, click the VeriFace icon on the desktop to register your facial image.

Notes:

- The face registration and verification works best in an environment with steady and even light.
- You can determine whether to use this function when you log on the system.

For more details on VeriFace, see the software help.

Chapter 2. Learning the basics

■ Using passwords

Using passwords helps prevent your computer from being used by others. Once you set a password and enable it, a prompt appears on the screen each time you power on the computer. Enter your password at the prompt. The computer cannot be used unless you enter the correct password.

Note: This password can be from one to seven alphanumeric characters in any combination.

For details about how to set the password, see the Help to the right of the screen in BIOS setup utility.

Note: To enter BIOS setup utility, press **F2** when the Lenovo logo appears on the screen while the computer is starting up.

■ ■ Enabling NVIDIA® Optimus™ (on select models)

Optimus is a GPU switching mechanism which automatically switches the active GPU to perform image-rendering tasks. If no graphics-intensive programs are running, the integrated GPU will be selected as the active GPU to preserve battery life; if you start high-definition movie playback or a 3D game, the image-rendering task is automatically switched by Optimus to the discrete GPU to produce high graphics performance.

Check the GPU indicator: if the indicator is off, slide and release the GPU switch to enable Optimus.

When Optimus is enabled, switching between integrated and discrete GPUs is performed automatically without user intervention. However, you can customize settings through the NVIDIA control panel to make the desired GPU active to perform image-rendering tasks for certain programs. For details, search for Optimus in the help system of the NVIDIA control panel.

Notes:

- Optimus is not supported by all operating systems. Currently, Optimus is supported by Windows® 7. If you are using another operating system, such as Windows® XP, it may not be able possible to enable Optimus.
- Optimus is not supported by all media players and video compression standards.

Chapter 3. Connecting to the Internet

As a global network, the Internet connects computers worldwide, providing services such as e-mailing, information searching, electronic commerce, Web browsing and entertainment.

You can connect the computer to the Internet in the following ways:

Wired connection: use physical wiring to connect.

Wireless network technology: connect without wiring.

■ ■ Wired connection

Wired connections are a reliable and safe way to connect the computer to the Internet.

Cable	Cable Internet services use a cable modem connected to the residential cable TV line.
DSL	DSL is a family of related technologies that bring high-speed network access to homes and small businesses over ordinary telephone lines.

Chapter 3. Connecting to the Internet

■ Hardware connection:

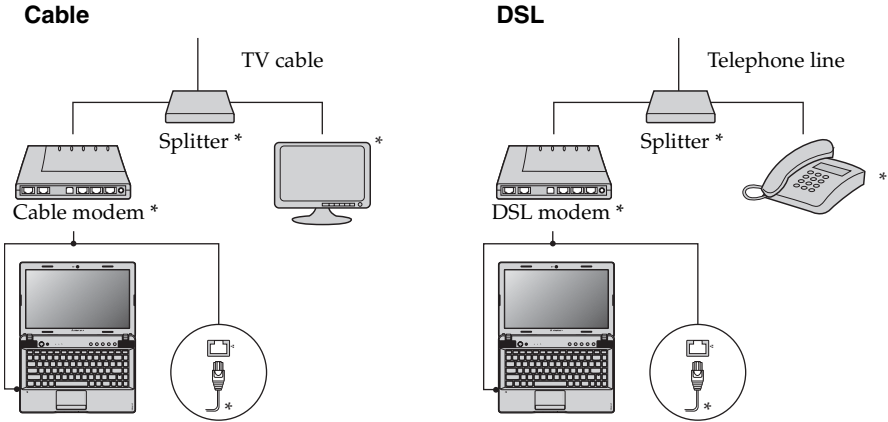

* Not supplied.

Note: The above diagrams are for reference only. Actual connection method may vary.

■ Software configuration

Consult your Internet Service Provider (ISP) for details on how to configure your computer.

■ ■ Wireless connection

Wireless connections provide mobile access to the Internet, allowing you to stay online anywhere the wireless signal covers.

Divided by the signal scales, wireless connection to the Internet can be built based on the following standards.

Wi-Fi	Wi-Fi networks cover a small physical area, like a home, office, or small group of buildings. An access point is necessary for the connection.
WiMAX	WiMAX networks connect several Wireless LAN systems to cover a metropolitan area, providing high-speed broadband access without the need for cables.



Note: Your computer may not support all wireless connection methods.

Chapter 3. Connecting to the Internet

■ Using Wi-Fi/WiMAX (on select models)

Enabling wireless connection

To enable wireless communications, do the following:

- 1 Slide the integrated wireless device switch from  to .
- 2 Press **Fn + F5** to make configuration.

Hardware connection

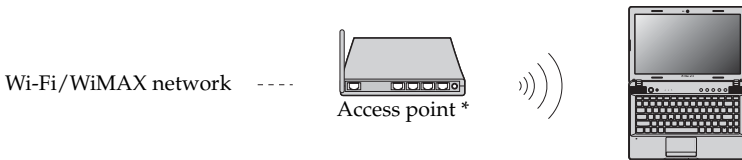

* Not supplied

Software configuration

Consult your Internet Service Provider (ISP) and search Windows Help and Support Center for details on how to configure your computer.

Chapter 4. OneKey Rescue system

■ ■ OneKey Rescue system

■ Introduction

The Lenovo OneKey Rescue system is an easy-to-use program that can be used to back up the data on your system partition (C drive) for easy restore when required. You can run Lenovo OneKey Recovery under the Windows operating system, and the OneKey Rescue system without starting the Windows operating system.

◎ **Attention:**

In order to utilize the features of the OneKey Rescue system, your hard disk already includes a hidden partition by default to store the system image file and OneKey Rescue system program files. This default partition is hidden for security reasons and is the reason the available disk space is less than it claims. The exact available hard disk space depends on the file size of the mirror image file (based on the size of operating system and preinstalled software).

■ Using Lenovo OneKey Recovery (within Windows operating system)

In Windows operating system, double click the OneKey Recovery system Icon on the desktop to launch Lenovo OneKey Recovery.

Within the program, you can back up the system partition on the hard disk drive, other storage devices, or by creating recovery discs.

Notes:

- The backup process and creation of recovery discs may take some time, connect the AC adapter and battery pack to your computer.
- After the recovery discs are burned, please number them so that you can use them in the correct order.
- Computers without an integrated optical drive support the creation of recovery discs; however an appropriate external optical drive is needed to physically create the recovery discs.

For more instructions, see the Help file of Lenovo OneKey Recovery.

Chapter 4. OneKey Rescue system

■ Using Lenovo OneKey Rescue system (without Windows operating system)

In the event that the operating system cannot be loaded, follow the steps below to access OneKey Rescue system.

- Shut down your computer.
- Press the **⌵** key to launch OneKey Rescue system.

Within the program, you can choose to restore your system partition to the original factory status, or to a previously generated backup.

Note: The recovery process is irreversible. Make sure to back up any critical data before using the recovery feature.

■ Creating a recovery disc(s)

Your computer does not ship with a recovery disc. You can use Lenovo OneKey Recovery system to create a recovery disc(s), which can be used to start and restore your computer in case of a system failure.

To create a recovery disc(s):

- Insert a recordable disc into the optical drive on your computer.

Note: If your computer does not come with an integrated optical drive or if the integrated optical drive does not support disc creating, connect an appropriate external optical drive to your computer.

- In Windows, press the OneKey Rescue system button to launch Lenovo OneKey Recovery system.

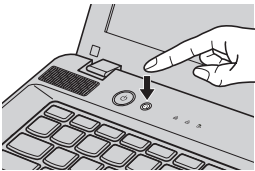

- On the main screen, click **Create Recovery Disc**.
- Choose the type of recovery disc(s). You can create three types of recovery disc(s): recovery disc(s) with existing backup image, recovery disc(s) from the current system partition, and factory default recovery disc(s). Select the type of recovery disc you want to create and follow the on-screen instructions.
- Insert additional recordable disc(s) when prompted.

Chapter 4. OneKey Rescue system

Notes:

- The estimated number of discs needed will be displayed before the process of creating the recovery disc(s) begins. To minimize the number of discs needed, use recordable DVDs as the media. Also make sure your optical drive is compatible with the disc intended for use.
- After recovery disc creation, number the discs appropriately for use in their correct order. The first disc created will be used to start the computer in the case of a system failure.

Chapter 5. Troubleshooting

■ ■ Frequently asked questions

This section lists frequently asked questions and tells where you can find detailed answers.

What safety precautions should I follow when using my computer?

See “Chapter 1. Important safety information” of *Lenovo Safety and General Information Guide*.

How can I prevent problems with my computer?

See “Chapter 2. Use and care Information” of *Lenovo Safety and General Information Guide*.

What are the main hardware features of my computer?

More information can be found in Chapter 1 and 2.

Where can I find the detailed specifications for my computer?

See <http://consumersupport.lenovo.com>.

I need to upgrade a device *or* I need to replace one of the following: the hard disk drive, memory, or the keyboard.

See “Appendix A. CRU instructions” on page 45 of this guide.

Where are the recovery discs?

Your computer did not come with a recovery disc. For an explanation of the alternative recovery methods offered by Lenovo, see “Chapter 4. OneKey Rescue system” on page 35.

Where are the installation discs for preinstalled programs?

Installation discs for preinstalled programs are not supplied with Windows preinstalled computers. You can visit the Lenovo consumer support Web site to find all preinstalled software downloads.

By default, you can find some installation backups for certain preinstalled software in the APP folder under the D driver.

How can I contact the customer support center?

See “Chapter 3. Getting help and service” of *Lenovo Safety and General Information Guide*.

Where can I find warranty information?

For the warranty applicable to your computer, including the warranty period and type of warranty service, see the Lenovo limited warranty flyer that came with your computer.

How can I install the device drivers?

A compatible device driver is a requirement to ensure correct operation and performance of each component in your computer. If your computer is pre-installed with an operating system, Lenovo provides all drivers that you need in your hard disk.

What can I do if the backup process fails?

If you can start the backup feature without a problem, but it fails during the backup process, please try the following steps:

- ❶ Close other programs, then restart the backup process.
- ❷ Check if the destination media is damaged, try to select another path and then try again.

When do I need to restore the system to the factory status?

You can use this feature when your system fails or you need to re-install your operating system. This will restore your computer back to the initial status when you first booted up your computer after receiving it from the store. If there is critical data on your current partition, back it up before you run this recovery feature.

Chapter 5. Troubleshooting

■ ■ Troubleshooting

If you do not find your problem here, see Chapter 2. The following section only describes problems that might negate the need to refer to the more comprehensive information in Chapter 2.

Display problems

When I turn on the computer, nothing appears on the screen.

- If the screen is blank, make sure that:
 - The battery is installed correctly.
 - The AC adapter is connected to the computer and the power cord is plugged into a working electrical outlet.
 - The computer power is on. (Press the power button again for confirmation.)
 - The memory is installed correctly.
- If these items are properly set, and the screen remains blank, have the computer serviced.

When I turn on the computer, only a white cursor appears on a blank screen.

- Restore backed-up files to your Windows environment or the entire contents of your hard disk to the original factory contents using OneKey Rescue system. If you still see only the cursor on the screen, have the computer serviced.

My screen goes blank while the computer is on.

- Your screen saver or power management may be enabled. Do one of the following to exit from the screen saver or to resume from sleep or hibernation mode:
 - Touch the touchpad.
 - Press any key on the keyboard.
 - Press the power button.
 - Press **Fn + F2** to confirm whether the backlight for the LCD screen has been turned off.

Password problems

- I forgot my password.
- If you forget your user password, you must take your computer to a Lenovo authorized servicer or a marketing representative to have the password changed.
 - If you forget your HDD password, a Lenovo authorized servicer cannot reset your password or recover data from the hard disk. You must take your computer to a Lenovo authorized servicer or a marketing representative to have the hard disk drive replaced. Proof of purchase is required, and a fee will be charged for parts and service.
 - If you forget your supervisor password, a Lenovo authorized servicer cannot reset your password. You must take your computer to a Lenovo authorized servicer or a marketing representative to have the system board replaced. Proof of purchase is required, and a fee will be charged for parts and service.

Keyboard problems

- A number appears when you enter a letter (Z370/Z470).
- The numeric lock function is on. To disable it, press **Fn + F8**.

Sleep or hibernation problems

- The critical low-battery error message appears, and the computer immediately turns off.
- The battery power is getting low. Connect the AC adapter to the computer, or replace the battery with a fully charged one.
- The computer enters sleep mode immediately after Power-on self-test (POST).
- Make sure that:
 - The battery is charged.
 - The operating temperature is within the acceptable range. See “Chapter 2. Use and care Information” of *Lenovo Safety and General Information Guide*.

Note: If the battery is charged and the temperature is within range, have the computer serviced.

Chapter 5. Troubleshooting

The computer does not return from sleep mode and the computer does not work.

- If the computer does not return from sleep mode, it may have entered hibernation mode automatically because the battery is depleted. Check the power indicator.
- If your computer is in sleep mode, connect the AC adapter to the computer, then press any key or the power button.
- If your computer is in hibernation mode or power-off state, connect the AC adapter to the computer, then press the power button to resume operation.

Note: If the system still does not return from sleep mode, your system has stopped responding, and you cannot turn off the computer; reset the computer. Unsaved data may be lost. To reset the computer, press and hold the power button for 4 seconds or more. If the computer is still not reset, remove the AC adapter and the battery.

Computer screen problems

The screen is blank.

- Do the following:
 - If you are using the AC adapter, or using the battery, and the battery status indicator is on, press **Fn + ↑** to make the screen brighter.
 - If the power indicator is in blinking, press the power button to resume from the sleep mode.
 - If the problem persists, follow the solution in the following problem "The screen is unreadable or distorted."
 - Press **Fn + F2** to confirm whether the LCD screen has been turned off.

The screen is unreadable or distorted.

- Make sure that:
 - The display device driver is installed correctly.
 - The screen resolution and color quality are correctly set.
 - The monitor type is correct.

Incorrect characters appear on the screen.

- Did you install the operating system or programs correctly? If they are installed and configured correctly, have the computer serviced.

Sound problems

No sound can be heard from the speaker even when the volume is turned up.

- Make sure that:
 - The Mute function is off.
 - The headphone jack is not used.
 - Speakers are selected as the playback device.

Battery problems

Your computer shuts down before the battery status indicator shows empty.

-or-

Your computer operates after the battery status indicator shows empty.

The computer does not operate with a fully charged battery.

- Discharge and recharge the battery.
- The surge protector in the battery might be active. Turn off the computer for one minute to reset the protector; then turn on the computer again.

A hard disk drive problem

The hard disk drive does not work.

- In the **Boot** menu in BIOS setup utility, make sure that the hard disk drive is included in the **Boot priority order** correctly.

A startup problem

The Microsoft® Windows operating system does not start.

- Use the OneKey Rescue system to help solve or identify your problem. For details about OneKey Rescue system, see “Chapter 4. OneKey Rescue system” on page 35.

OneKey Rescue system problems

Backup cannot be made.

- You are not currently using a Windows operating system.
- There is not enough space to store the backed up data. You will need to free more hard disk space on your system partition (C drive).

Fail to restore system partition to factory default.

- The system partition, such as the partition size or the drive capacity of C, has been modified.

Chapter 5. Troubleshooting

Other problems

Your computer does not respond.

- To turn off your computer, press and hold the power button for 4 seconds or more. If the computer still does not respond, remove the AC adapter and the battery.
- Your computer might lock when it enters sleep mode during a communication operation. Disable the sleep timer when you are working on the network.

The computer does not start from a device you want.

- See the **Boot** menu of the BIOS setup utility. Make sure that the **Boot priority order** in the BIOS setup utility is set so that the computer starts from the device you want.
- Also make sure that the device from which the computer starts is enabled. In the **Boot** menu in the BIOS setup utility, make sure that the device is included in the **Boot priority order** list.
- Press **F12** when the Lenovo logo appears on the screen while the computer is starting up to select the device you want the computer starts from.

The connected external device does not work.

- Do not connect or disconnect any external device cables other than USB while the computer power is on; otherwise, you might damage your computer.
- When using a high power consumption external devices such as an external USB optical disk drive, use external device power adapter. Otherwise, the device may not be recognized, or system shut down may result.

Appendix A. CRU instructions

Note:The illustrations used in this chapter are of the Lenovo IdeaPad Z370, unless otherwise stated.

●● Replacing the battery pack

Note: Use only the battery provided by Lenovo. Any other battery could ignite or explode.

To replace the battery pack, do the following:

- 1 Turn off the computer, or enter hibernation mode. Disconnect the AC adapter and all cables from the computer.
- 2 Close the computer display, and turn the computer over.
- 3 Unlock the manual battery latch **1**. Holding the spring-loaded battery latch in the unlocked position **2**, remove the battery pack in the direction shown by the arrow **3**.

Z370/Z470

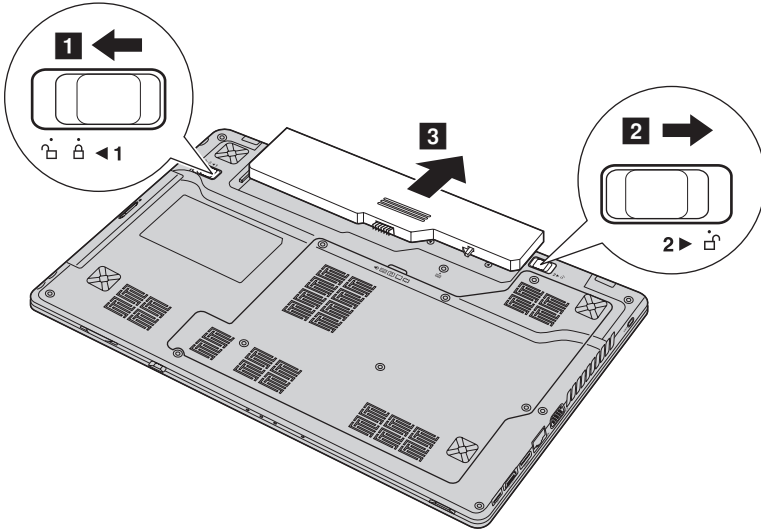

Appendix A. CRU instructions

Z570

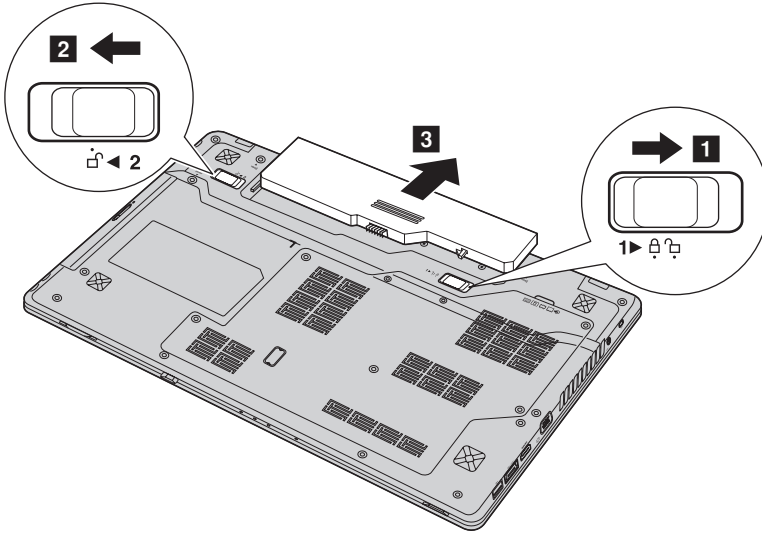

- ④ Install a fully charged battery pack.
- ⑤ Slide the manual battery latch to the locked position.
- ⑥ Turn the computer over and reconnect the AC adapter.

■ ■ Replacing the hard disk drive

You can increase the storage capacity of your computer by replacing the hard disk drive with one of greater capacity. You can purchase a new hard disk drive from your reseller or Lenovo marketing representative.

Notes:

- Replace the hard disk drive only if you upgrade it or have it repaired. The connectors and bay of the hard disk drive were not designed for frequent changes, or drive swapping.
- The preinstalled software are not included on an optional hard disk drive.

Handling a hard disk drive

- Do not drop the drive or subject it to physical shocks. Put the drive on a material, such as soft cloth, that absorbs the physical shock.
- Do not apply pressure to the cover of the drive.
- Do not touch the connector.

The drive is very sensitive. Incorrect handling can cause damage and permanent loss of data on the hard disk. Before removing the hard disk drive, make a backup copy of all the information on the hard disk, and then turn the computer off. Never remove the drive while the system is operating, in sleep mode, or in hibernation mode.

Appendix A. CRU instructions

Z370:

To replace the hard disk drive, do the following:

- ❶ Turn off the computer; then disconnect the AC adapter and all cables from the computer.
- ❷ Close the computer display, and then turn the computer over.
- ❸ Remove the battery pack.
- ❹ Remove the Hard disk drive/Memory/Central processing unit/Mini PCI Express Card slot compartment cover.
 - a. Loosen the screws that secure the compartment cover ❶.
 - b. Remove the compartment cover ❷.

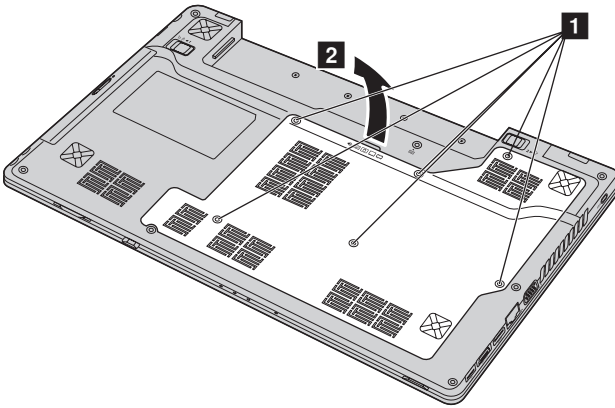

- 5 Remove the frame fixing screws 3.

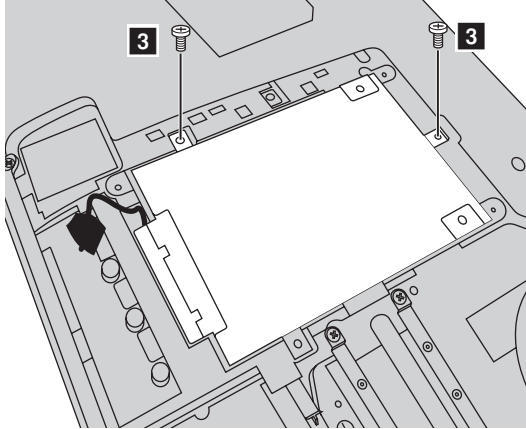

- 6 Carefully remove the hard disk drive (secured in the metal frame) from the compartment 4.

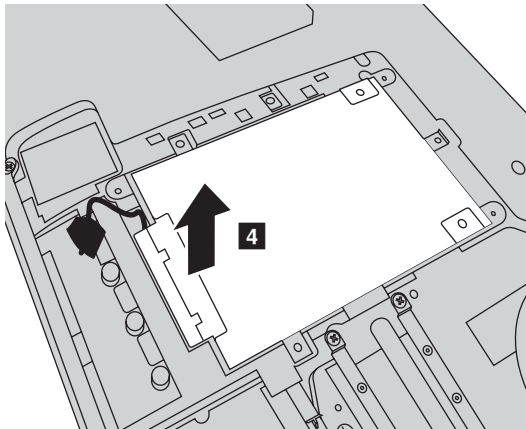

Note: Be sure to remove the hard disk (secured in the metal frame) gently to avoid breaking the connection to the SATA receptacle connector.

Appendix A. CRU instructions

- 7 Hold the SATA receptacle connector with one hand and pull the hard disk drive (secured in the metal frame) in the direction shown below to detach the connectors **5**.

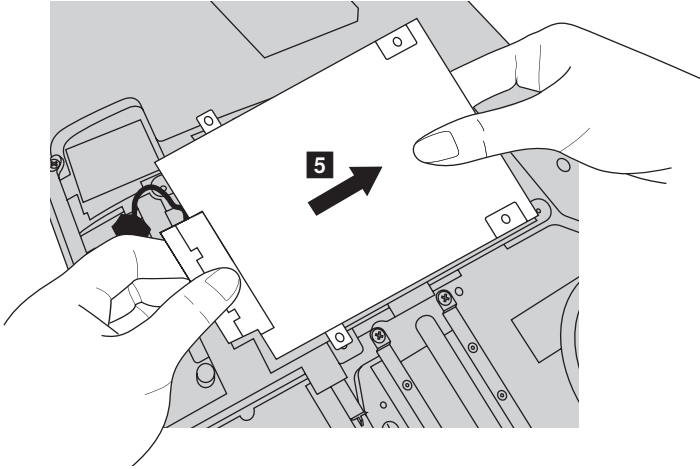

- 8 Remove the screws and detach the metal frame from the hard disk drive.
- 9 Attach the metal frame to a new hard disk drive and tighten the screws.
- 10 Reconnect the hard disk drive (secured in the metal frame) to the SATA receptacle connector, then carefully reinstall the hard disk drive in the compartment with the tab facing upwards.
- 11 Reinstall the frame fixing screws.
- 12 Reinstall the compartment cover and tighten the screws.
- 13 Reinstall the battery pack.
- 14 Turn the computer over again. Connect the AC adapter and the cables to the computer again.

Z470/Z570:

To replace the hard disk drive, do the following:

- ❶ Turn off the computer; then disconnect the AC adapter and all cables from the computer.
- ❷ Close the computer display, and then turn the computer over.
- ❸ Remove the battery pack.
- ❹ Remove the Hard disk drive/Memory/Central processing unit/Mini PCI Express Card slot compartment cover.
 - a. Loosen the screws that secure the compartment cover **❶**.
 - b. Remove the compartment cover **❷**.

Z470

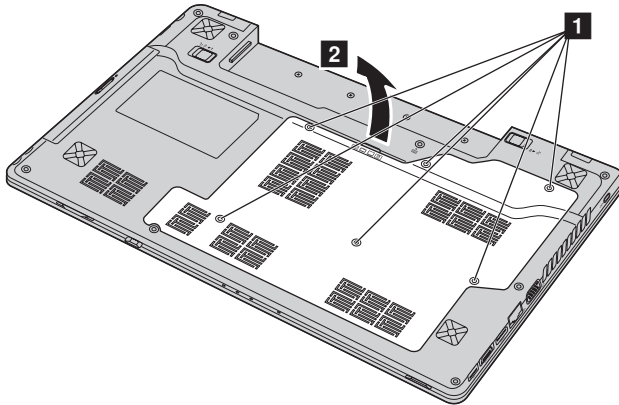

Appendix A. CRU instructions

Z570

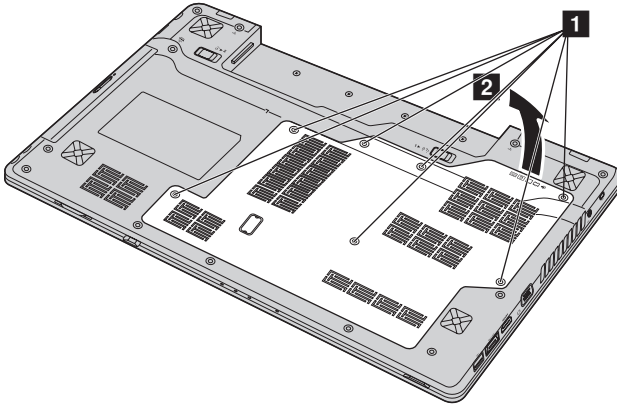

- 5 Remove the frame fixing screws 3 .

Z470

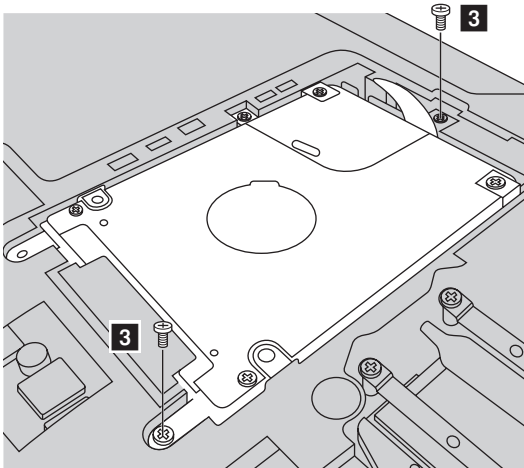

Z570

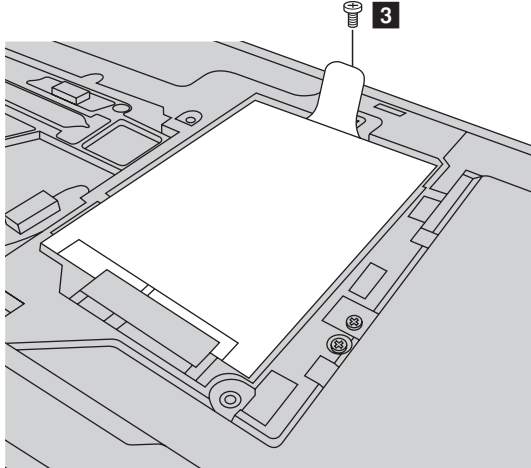

6 Pull the tab in the direction shown by arrow 4.

Z470

- a. Hold the tab to lift the hard disk drive a little by arrow 4'.
- b. Pull the tab in the direction shown by arrow 4.

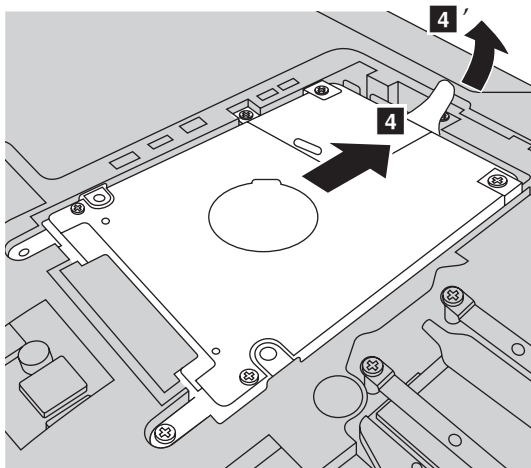

Appendix A. CRU instructions

Z570

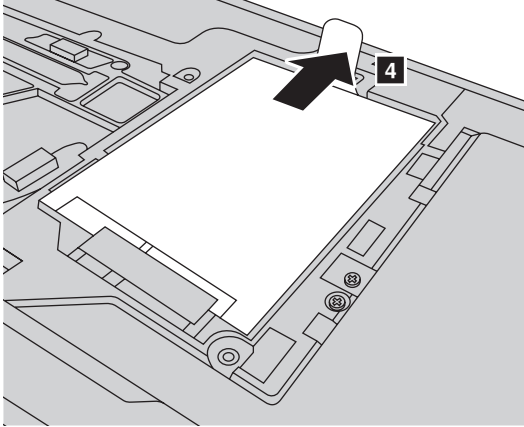

- 7 Take out the hard disk drive secured in a metal frame 5 .

Z470

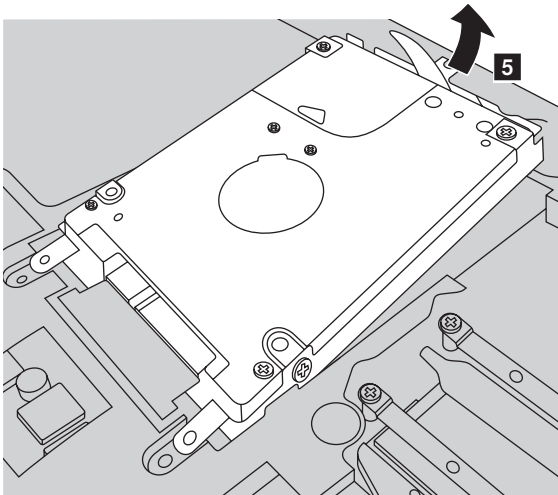

Z570

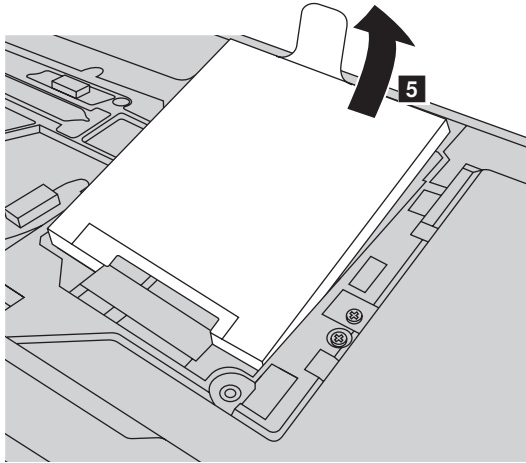

- ⑧ Remove the screws and detach the metal frame from the hard disk drive.
- ⑨ Attach the metal frame to a new hard disk drive and tighten the screws.
- ⑩ Put the hard disk drive gently into the hard disk drive bay with the tab facing upwards and the connectors facing each other; then push it firmly into space.
- ⑪ Reinstall the frame fixing screw.
- ⑫ Reinstall the compartment cover and tighten the screws.
- ⑬ Reinstall the battery pack.
- ⑭ Turn the computer over again. Connect the AC adapter and the cables to the computer again.

■ ■ Replacing memory

You can increase the amount of memory in your computer by installing a double-data-rate three synchronous dynamic random access memory (DDR3 SDRAM)-available as an option-in the memory slot of your computer. DDR3 SDRAMs are available in various capacities.

Note: Use only the memory types supported by your computer. If you incorrectly install optional memory, or install an unsupported memory type, a warning beep will sound when you try to start the computer.

To install a DDR3 SDRAM, do the following:

- ❶ Touch a metal table or a grounded metal object to reduce any static electricity in your body, which could damage the DDR3 SDRAM. Do not touch the contact edge of the DDR3 SDRAM.
- ❷ Turn off the computer. Disconnect the AC adapter and all cables from the computer.
- ❸ Close the computer display, and turn the computer over.
- ❹ Remove the battery again.
- ❺ Remove the Hard disk drive/Memory/Central processing unit/Mini PCI Express Card slot compartment cover.
 - a. Loosen the screws that secure the compartment cover ❶.
 - b. Remove the compartment cover ❷.

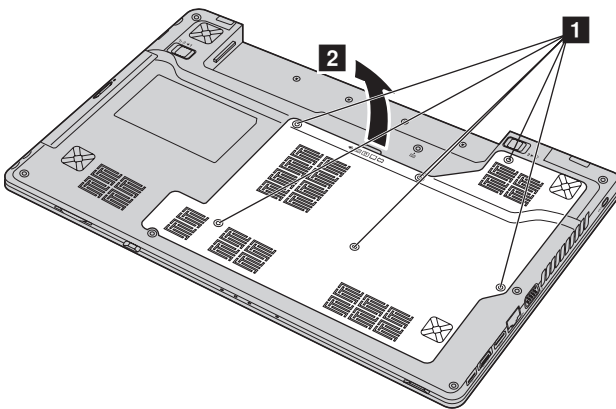

Appendix A. CRU instructions

- 6 If two DDR3 SDRAMs are already installed in the memory slot, remove one of them to make room for the new one by pressing out on the latches on both edges of the socket at the same time. Be sure to save the old DDR3 SDRAM for future use.

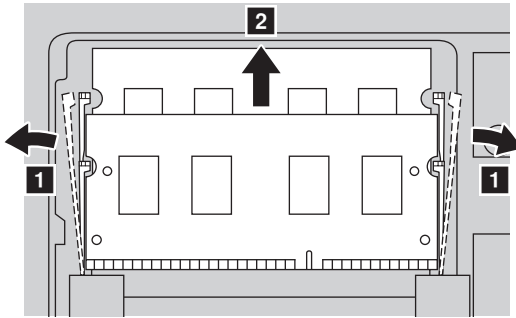

- 7 Align the notch of the DDR3 SDRAM with the protrusion of the socket and gently insert the DDR3 SDRAM into the socket at a 30-45° angle.
- 8 Push the DDR3 SDRAM inward toward the socket until the latches on both edges of the socket are pushed into the closed position.

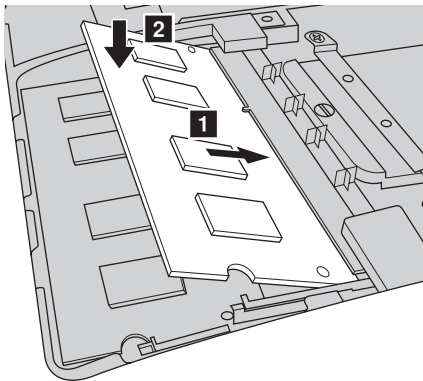

- 9 After aligning the attachment clips with their matching gaps, reinstall the compartment cover.
- 10 Reinstall and tighten the screws.
- 11 Reinstall the battery.
- 12 Turn the computer over again. Connect the AC adapter and the cables to the computer again.

Appendix A. CRU instructions

Note: If only one DDR3 SDRAM is used on the computer you are servicing, the card must be installed in SLOT-0 (**a**: lower slot), but not in SLOT-1 (**b**: upper slot).

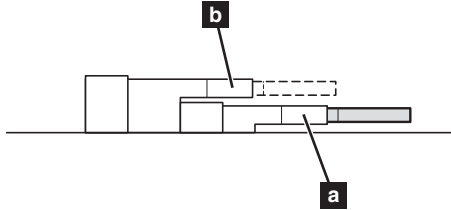

To make sure that the DDR3 SDRAM is installed correctly, do as follows:

- 1 Turn the computer on.
- 2 Hold F2 during startup. The BIOS setup utility screen opens. The **Total Memory** item shows the total amount of memory installed in your computer.

■ ■ Removing the optical drive

To remove the optical drive, do the following:

- 1 Remove the Hard disk drive/Memory/Central processing unit/Mini PCI Express Card slot compartment cover.
- 2 Remove the screw shown in the illustration **1**.
- 3 Gently pull the optical drive out **2**.

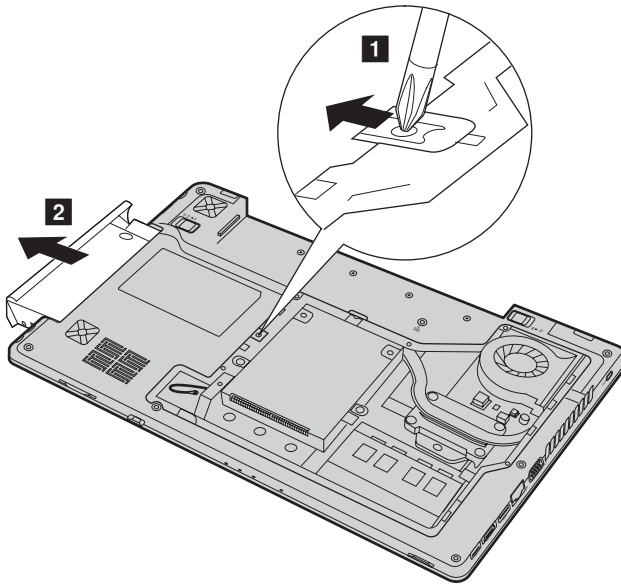

Appendix A. CRU instructions

The following table provides a list of CRUs for your computer, and informs you of where to find replacement instructions.

	Setup Poster	User Guide
AC adapter	○	
Power cord for AC adapter	○	
Battery pack	○	○
Bottom access doors		○
Hard disk drive		○
Memory		○
Optical drive		○

Trademarks

The following terms are trademarks or registered trademarks of Lenovo in the United States, other countries, or both.

Lenovo
IdeaPad
OneKey
VeriFace

Microsoft and Windows are trademarks of Microsoft Corporation in the United States, other countries, or both.

NVIDIA and Optimus are trademarks and/or registered trademarks of NVIDIA Corporation in the United States and other countries.



is a trademark of SRS Labs, Inc.

Premium Surround Sound technology is incorporated under license from SRS Labs, Inc.

SRS Premium Surround Sound™ provides the ultimate audio experience for music, movies and games on the PC.

Other company, products, or service names may be trademarks or service marks of others.

lenovo[®]

New World. New Thinking.[™]
www.lenovo.com

©Lenovo China 2010

V1.0_en-US